

GB

Instructions for Use

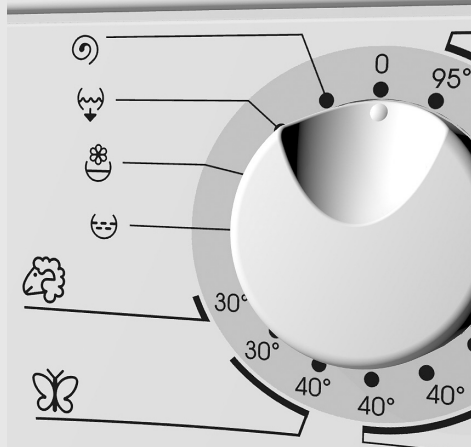

Washing machine



Thank you for your confidence in purchasing our washing machine, and congratulations on the excellent choice.

Your new washing machine meets the requirements of modern treatment of laundry. It is rational in the consumption of energy, water and washing agents. Our appliances are friendly to the environment. Some of the materials may be recycled, others deposited or decomposed. To avoid pollution of environment, once your appliance is no longer useful, take it to your local authorized waste appliance dealer.

The appliance is intended exclusively for use in households. If the appliance is used for professional purposes, for profit, or for purposes beyond regular use in a household, or if appliance is used by a person who is not a consumer, the warranty period equals the shortest warranty period possible as stipulated by the relevant legislation.

Description of washing machine	3
Cautions	4
Installation and connection	6
Operation.....	11
Tips for washing and energy saving	18
Cleaning and maintenance	20
Failures.....	23
Tables	26

Description of washing machine

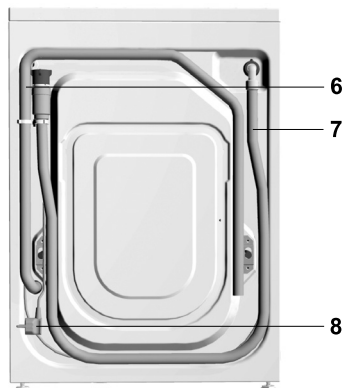
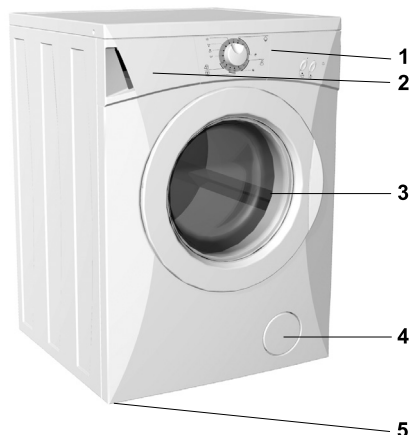

- 1. Front panel
- 2. Detergent dispenser
- 3. Door
- 4. Filter lid

- 5. Adjustable legs
- 6. Water outlet hose
- 7. Water inlet hose
- 8. Mains power cable

Technical information

Dimensions (w x d x h):

600 mm x 600 mm x 850 mm

Depth with door open: 106 cm

Weight (net): 90 kg

Nominal voltage: 230 V, 50 Hz

Power: 2300 W

Max. load: 6 kg

Power socket: (230 V, 50 Hz, 10 A)

Water pressure: min. 0,05 MPa, max. 0,8 MPa

Fuse: 10 A



Cautions



- Be sure to remove transport brackets prior first use of the appliance. Attempted operation of the blocked machine may result in irreparable damage which is not covered by the manufacturer's warranty!
- When connecting your washing machine to water supply, be sure to use brand new water inlet hose and appropriate sealing gaskets (attached).
- Do not locate the machine in a room with temperature below 0°C. Parts of the machine may be damaged if frozen.
- Install the washing machine in a perfectly horizontal position, on solid flat concrete floor.
- Follow the instructions for correct installation and water and mains connections.
- Never immerse the end of the drain hose into the draining water.
- Prior starting the washing cycle lock the door by pressing them at the designed spot.
- Door may not be open during the washing cycle.
- Use only detergents and softeners for machine wash. Manufacturer may not assume responsibility for any damage and eventual discoloring of gaskets and plastic components as a consequence of incorrect use of bleach and/or coloring agents.
- For removal of lime residues use such agents with added anti-corrosion agents. Follow the manufacturer's instructions. Finish the lime removal by multiple rinsing to remove completely eventual acid residues.
- Never use detergents containing solvents, since there is a danger of creating toxic gasses which may damage the machine and result in ignition or explosion.
- Upon completion of washing operation close the water tap.
- Before any transport block the machine by inserting at least one transport blocking rod. Prior this operation disconnect the appliance from the mains power!
- Rating plate with basic information is located above the opening of the machine.
- The warranty shall not apply to consumables (bulbs), minor discoloration or deviations of color, increased noise level as a consequence of appliance age, which does not affect appliance functionality, and aesthetical deficiencies which do not affect appliance functionality or safety.



 **Before connecting the appliance read these instructions carefully. Repairing the failure arising from inappropriate connections or use of the appliance is not covered by the guarantee.**

 **The symbol on the product or on its packaging indicates that this product  may not be treated as household waste. Instead it shall be handed over to the applicable collection point for the recycling of electrical and electronic equipment. By ensuring this product is disposed of correctly, you will help prevent potential negative consequences for the environment and human health, which could otherwise be caused by inappropriate waste handling of this product. For more detailed information about recycling of this product, please contact your local city office, your household waste disposal service or the shop where you purchased the product.**

Installation and connection



Package removal

- ⚠ In removing the wrapping be careful not to damage the appliance with a sharp object.
- ⚠ Before connecting the appliance, let it warm up to room temperature (wait for two hours).

- Our appliances are packed in environmentally friendly materials which may be recycled, deposited or decomposed without any threat to the environment.
- To this end all wrappings are marked accordingly.

Removal of transport brackets



- Move the pipes.
- Loosen screws A at the rear of the machine (Fig. 1).
- Remove the brackets B (Fig. 1) and slide them into the groove on the blocking rod (Fig. 2) - the right one should be turned around.
- Use the brackets to rotate blocking rods for 90° and pull them out.
- Close the openings with attached plastic pegs. Save transport brackets for eventual later use.

- ⚠ Be sure to remove the transport brackets prior first use, otherwise the appliance may be permanently damaged. In such cases the warranty conditions are void.

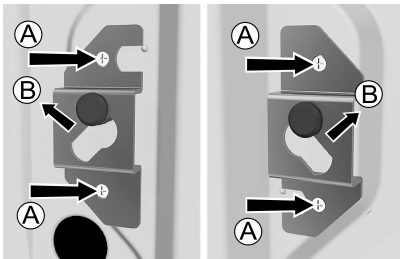

Fig. 1

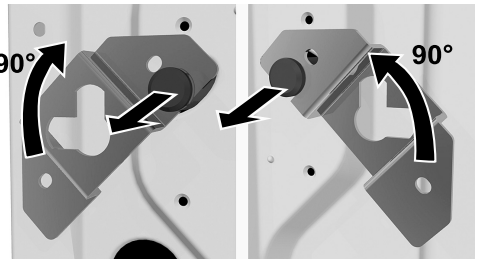
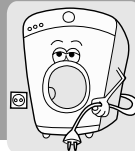
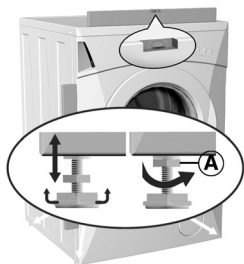

Fig. 2



Leveling the appliance



- Put the appliance in horizontal position by turning the adjustable legs. The legs are adjustable up to +/- 1 cm.

After the adjustment tighten the nuts firmly (A) - towards the bottom of the machine!

⚠ **Vibrations, moving of the appliance and loud operation due to incorrect setting of the adjustable feet shall not be covered by this warranty.**

⚠ **The appliance should be placed on a surface with concrete base; the surface should be dry and clean in order to prevent slipping. The adjustable feet should also be cleaned before installation.**

- If you have a tumble dryer of the same dimensions, you can place it on top of the washing machine.



Water inlet connection

⚠ **To ensure correct operation of the appliance, water pressure inlet must be between 0,05 and 0,8 MPa.**

⚠ **Minimum water pressure can be established by measuring the quantity of poured out water. 3 litres of water must be poured out from completely opened tap in 15 seconds.**



- Insert the gasket with screen into the water inlet hose thread Screw the hose thread to the water faucet



Water outlet connection

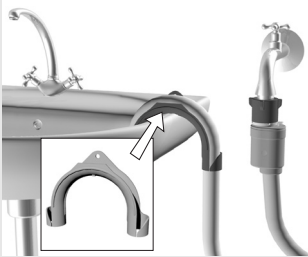

- Fix the outlet hose to run into the sink or the bathtub, or connect it directly to the wall drain outlet (diameter min. 4 cm).
- Wall drain must be installed properly and must enable occasional cleaning.
- Fasten the outlet hose support with a piece of rope led through the hose elbow, to prevent the hose from slipping to the floor.
The end of outlet hose should be placed between minimum 60 cm and maximum 100 cm above the floor level.

Connect the appliance to the mains supply

- Plug the mains power cable to the wall mains socket.
- Required voltage and other information are written on the rating plate above the door opening of the machine.

⚠ The wall socket must be accessible at all times and must be equipped with an earth lead (in accordance with the local safety regulations).

⚠ The permanent connection must be fitted by an authorized personnel only.

⚠ Damaged mains power cable may be replaced only by the producer or his authorized personnel.

⚠ Never plug the appliance into the electric shaver socket or hair dryer socket.

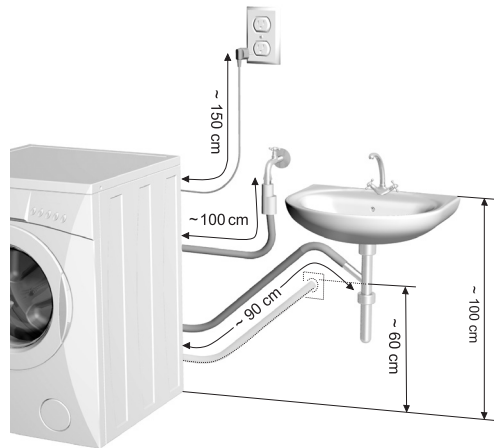
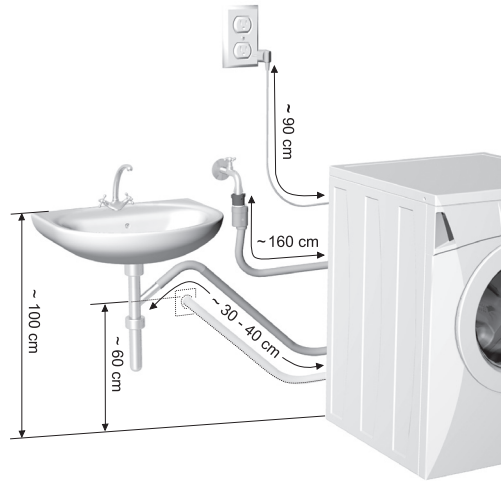



⚠ This appliance must be earthed!

Connect the appliance with the cable and plug to a suitable 13 amp socket which is properly earthed. Required nominal voltage and frequency are indicated on the rating plate.

The connection to the mains supply and earthing have to be made according to current standards and regulations. The appliance resists temporary voltage tolerance up to -15 to +10 %.

If the fitted plug is not suitable for your socket outlet, then it should be cut off and disposed of safely in order to avoid a possible shock hazard.

A suitable plug of 13 amp or 15 amp rating should then be fitted to the cable.

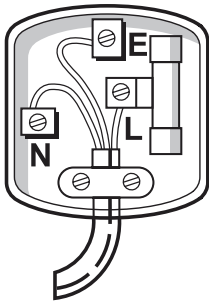

CONNECT GREEN AND YELLOW TO EARTH (E)

CONNECT BROWN TO LIVE (L)

CONNECT BLUE TO NEUTRAL (N)

MAKE SURE THE CABLE IS HELD BY THE CLAMP

The wires in the mains lead are coloured in accordance with the following code (see fig.).

1. The GREEN AND YELLOW wire must be connected to the terminal in the plug, which is marked with the letter E or by the earth, symbol or coloured green or green and yellow.
2. The BLUE wire must be connected to the terminal which is marked with the letter N or coloured black.
3. The BROWN wire must be connected to the terminal which is marked with the letter L or coloured red.

Operation

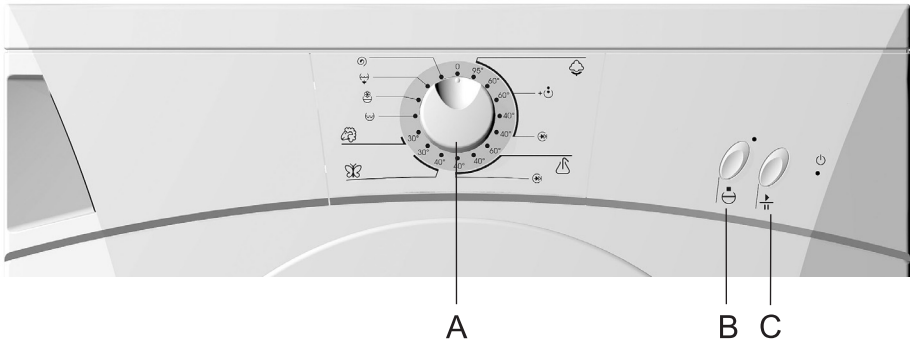

A - program selector
B - pump stop knob
C - START/PAUSE knob

Signal LED's: - ON/OFF (orange)
 - pump stop/failure (green)

Program selector	Basic programs	Partial programs	
	Cotton Pre-wash Short program	Rinse	
	Synthetics Short program		
	Delicate	Pumping water	
	Wool	Spinning	

Washing procedure

- Open the door of the machine
- Load the laundry into the drum
- Close the door
- Open the water inlet tap
- Select the program by turning program selector (A)
- Add washing and treatment agents (detergent and softener)
- Start the operation by pushing the START knob (C)



- **Open the door of the machine.**
Door is opened by pulling the handle (lever) on the right hand side of the door towards you.
- **Sort the laundry by the type of fabrics.**

- ⚠ **Do the buttons and zippers, tie the strings and pull out the pockets.**
- ⚠ **Very delicate laundry should be put in a special protective sack.**
- ⚠ **It is suggested to load the drum with items of different sizes.**
- ⚠ **Pay attention to the labels on the clothes, indicating the recommending washing mode (see table of textile treatment symbols on the last page of these instructions).**

- **Load the laundry into the drum.**
Check that the drum is empty.
- **Close the door of the appliance.**
- **Open the water inlet tap.**
- **Select washing program (A) and push START knob (C).**

Washing machine operation

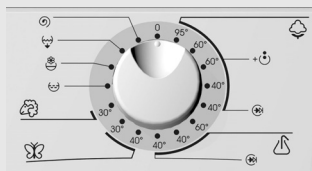

Program is selected by turning the program selector (A) from the "0" position to the desired washing program. The ON/OFF signal LED starts flashing. The program selector (A) may be turned in both directions, and the appropriate program selected according to the type of laundry washed and the required washing temperature (see Program Chart for help). You may select basic or partial programs. Selected program may be changed at random prior pushing the START knob (C).

- Selection of basic programs (☁, ⚗, 🌸, 🧺)

Basic programs represent integral programs containing all washing stages,



including softening and spinning (see Program Chart). They are selected by turning the program selector to the appropriate position.

Cotton: whites/colored

Normally stained cotton and flax bed linen and underwear, table cloth, bathroom towels, top garments, etc.

For less stained laundry of this type, use short program. It saves energy and washing time.

For heavily stained permanent press use the program with the pre-wash ☺.

Synthetics

Normally stained shirts, blouses and other polyester and polyamide garments, or a mixture of these fabrics with cotton.

For less stained laundry of this type, use short program. It saves energy and washing time.

Delicate

This is a program for delicate fabrics (dresses, skirts, blouses) and curtains.

Wool

Especially gentle program for washing wool and garments made from mixture of other fabrics with wool, appropriately marked for machine washing.

- Selection of additional function

Pump stop

- This function is switched on after the selection of a basic program by pressing the  knob (B). It may also be switched on during the operation, prior last rinse. Indicator LED above the washing cycle symbol is lit.
- The function is switched off by pressing the same knob again - signal LED is off.

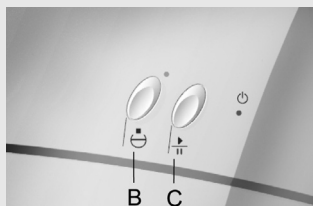



- The program stops at the end of last rinse, prior spinning: laundry remains soaked in water and prevents crease, if you are unable to remove it from the drum immediately after the end of washing cycle. Indicator LED above the knob is flashing.
- The selected program is completed by pushing the START knob (C), but you may also apply additional programs (pumping or spinning), but you must first return the program selector to the “0” position for at least one second, prior selecting any of the additional programs. When program continues, indicator LED above the knob goes off.

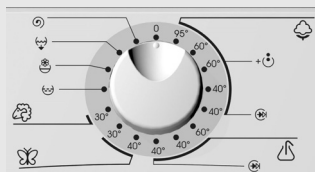

- **Selection of partial programs** (☺, 🌸, 💧, 🌀)

These are independent programs and may be used when you do not need the entire washing program. In case you would like to use more additional programs in a sequence, you must turn off the appliance prior any new program selection (turn the program selector to “0” for at least one second).

☺ **Rinse**

Independent program for rinsing delicate laundry, without intermediate spinning and with short final spin. You may use it for rinsing manually washed delicate laundry or for extra rinsing for people with skin sensitive to detergents.

🌸 **Softening**

This program is intended for softening, bleaching or impregnating of washed laundry. It is completed with spinning at max. 1000 RPM.

💧 **Pumping the water out**

Use it when the washing program was interrupted or if pump stop function was engaged, and you only wish to pump the water out of the drum, without spinning.



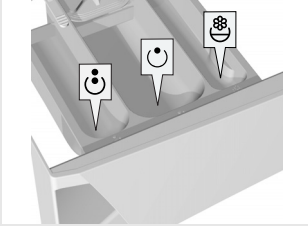

Spinning

Aggressive spinning for non-delicate laundry at high spin RMP.





- **Adding washing and softening agents**

(see Tips for washing and energy saving)

- pre-wash compartment 
- main wash compartment 
- softener compartment 

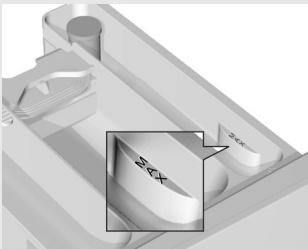
Washing detergent may be added directly into the drum, using the measuring vessel.



 **When adding softener, be careful to fill the dispenser only up to the marked level.**

 **Be sure to close the detergent dispenser when opening/closing the appliance door.**

Start the operation

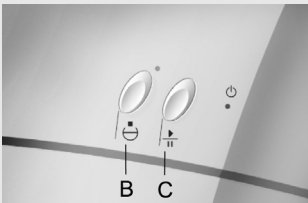

- Push the START knob (C). The ON/OFF LED stops flashing, the machine starts operating after a few seconds. If the door is not properly closed after starting the operation, the ON/OFF LED starts flashing again after a few seconds. When you close the door, the machine initiates the selected program.
- In case you would like to alter the washing program after the initiated washing operation, turn the program selector for one second to the position 0, followed by the selection of a new program. Switching the machine off deletes any previously selected additional functions (i.e. PUMP STOP) , so they have to be reactivated.



- End of operation

Flashing ON/OFF LED indicates that the program was completed.

- Extract the laundry from the drum and remove any alien objects from the door gasket.
- Leave the door ajar to allow the interior to dry.
- Close the water inlet tap.
- Switch the machine off by turning the program selector to position "0".

Interruptions

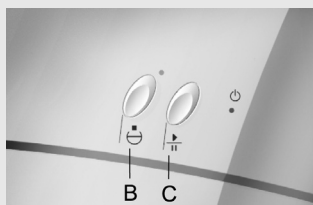

• By the user

Selecting Pump stop function

Program is stopped when it comes to the PUMP STOP  stage (if this function had been previously selected). Drum door remains closed all the time. Indicator LED above the 'Pump stop' function starts flashing. Washing procedure is continued by pressing the START knob (C).

Own (physical) interruption

You may also stop the program by turning the program selector to the position "0". If there is water in the drum select one of additional programs (pumping, spinning) to empty the water and terminate the program.

Pause knob

By pressing the PAUSE knob (C) program may be suspended at any time. After certain time you may open the door if there is no water in the drum, otherwise this is not possible. Program is continued by pressing the START knob (C).

• Failures

Program is suspended in case a failure occurs. Signal LED's are flashing (see cf. Troubleshooting).



- **Power failure**

At electric cutout the program is interrupted, however, after the power supply has been re-established, the program operation automatically proceeds.

 **If a power failure occurs when the drum is still full of water, be careful not to open the door before you pump the water out.**

Tips for washing and energy saving



- Before washing sort out the laundry according to the type, degree of dirtiness and color fastness.
- Prior selecting the washing program consult the sewn tab with information on a particular piece of laundry (see **Maintenance chart** on the last page).
- Wash separately the new colored textile products for the first time.
- Wash heavily soiled laundry in small quantities and add more detergent.
- Treat stubborn stains with special stain remover, it will save energy.
- With lightly stained laundry select washing program without pre-wash, use short program and select lower washing temperature. This way you may save up to 50% of energy.
- Avoid washing too little quantities of laundry because of energy saving and for better performances of the appliance.
- The largest allowed quantity of dry laundry is indicated in the **Program chart**.
- Before washing empty the pockets, close zip fasteners, and remove any metal fasteners or badges that might clog the drain or damage the laundry or drum interior.
- Loosen the stacked laundry prior inserting it into the drum.
- Use only detergents for machine wash.
- Add powder or liquid detergents according to the manufacturer's instructions.
- If water hardness level exceeds 14°dH degrees, the use of water conditioner is required. Any damage to the heater due to failure to use a water conditioning agent shall not be covered by this warranty.
- Chlorine-based whitening agents are not recommended, as it can damage the heater.



Hardness scale	Degree of hardness			
	°dH(°N)	m mol/l	°fH(°F)	p.p.m.
1 - Soft	< 8,4	< 1,5	< 15	< 150
2 - Medium	8,4 - 14	1,5 - 2,5	15 - 25	150 - 250
3 - Hard	> 14	> 2,5	> 25	> 250

In case of hard water add detergent according to the Chart for degree 1 and add appropriate quantity of water softener (see manufacturer's instructions).

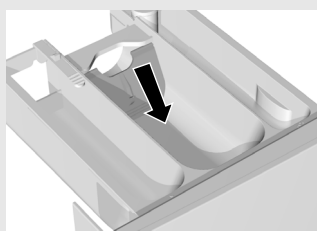
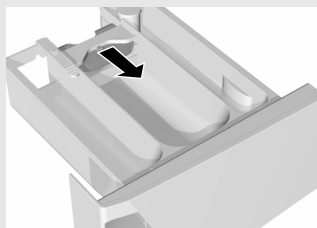

- If you do not apply the program which includes the pre-wash feature, you may add washing detergent directly into the drum.
- If you use thick liquid softener it is recommended to dilute it with water, to prevent clogging of dispenser compartment ducts.
- Washing machine is equipped with the dispenser partition gate, so you may pour liquid detergent also into the central compartment. If you use powder detergent the gate is lifted up, and in case of liquid detergent it is slid down.
- Liquid detergents are intended for main wash only, without pre-wash.
- Insert particularly delicate linen (stockings, delicate female underwear, etc.) into the special bag.
- High spin RPM leave less moisture in laundry which dries out much quicker in the tumble dryer, thereby saving energy.

 **Do not put clods of detergent into the soap dispenser as the tube in the washing machine may clog.**

Cleaning and maintenance



⚠ Disconnect the washing machine from the mains before cleaning!

- The casing should be cleaned with soft cloth and mild detergent.
- The interior of the drum and the door gasket is cleaned by washing at 60°C without laundry and adding half quantity of detergent.
- If necessary, clean the detergent dispenser. Pull it out from its casing completely by pressing the flap (see Fig.).

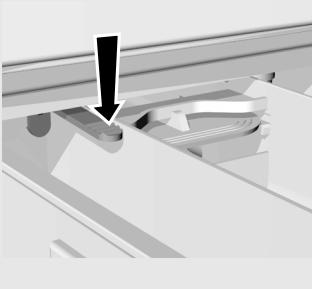

- If necessary, clean the cover of the bung under the running water.



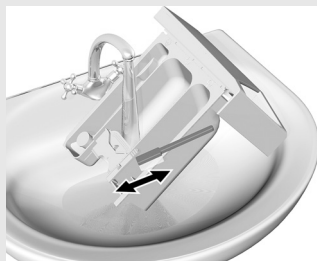

- Wash it under running water using a brush, and dry it. Remove any leftover dried detergent from the bottom of the casing.

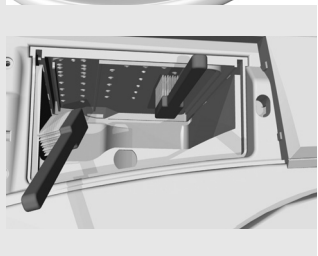

- Clean the entire rinsing area of the washing machine with a brush, especially the nozzles on the upper side of the rinsing chamber.

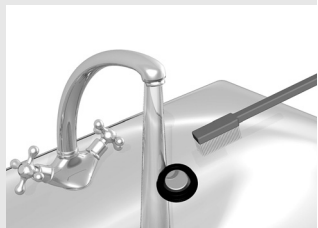

- Clean frequently the water inlet hose screen under running water.
- After each wash wipe the door rubber gasket. This will prolong its useful life.

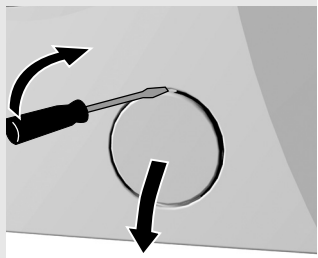

- Open the filter lid using flat screwdriver or similar tool.



- Filter needs occasional cleaning, especially following heavily shaggy or old laundry.

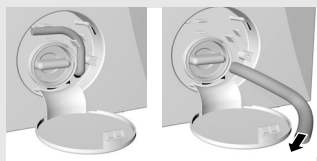

- Before cleaning, drain any water from the machine via drain pipe (certain models only).

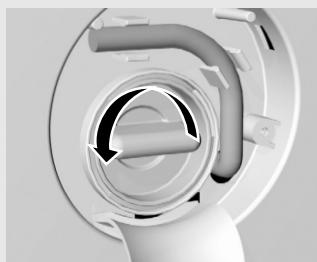

- Turn it anti-clockwise, pull it out and clean under running water.

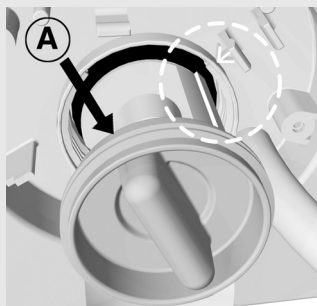

- Insert the filter back as shown on the picture (arrow and pointer), and tighten by turning it in clockwise direction. To ensure good sealing the gasket surface (A) must be dirt free.

Failures



The washing machine automatically monitors the execution of particular functions during the operation, and reports any detected failures. In such cases both signal LED's start flashing in certain sequence. Flashing sequence changes in accordance with the nature of the detected failure.

In some cases you may attempt removing certain failures yourself, so count the number of flashes, repeating after certain pauses.

The machine signals failures immediately after detecting them and stops the program, except for heater failure, where the machine completes the washing program without heating water.

Failures:

In certain cases you may remove the failure yourself:

- 2 - two flashes: door is not correctly closed;
- 3 - three flashes: inappropriate water intake;
- 7 - seven flashes: inappropriate water outlet.

In all other instances mark the number of flashes indicating the failure, switch off the machine and call nearest authorized service center (LED's continue flashing until you switch the machine off).

Interferences from the ambient (for example electrical wiring) could induce signalization of different faults. In such cases:

- switch the appliance off, and wait for a few seconds;
- switch the appliance back on and repeat the washing program.

If the fault repeats, call authorized service shop.

Warranty shall not apply in case of failures due to interferences from the environment (lightning stroke, power supply circuit faults, natural disasters).



Failure	Possible cause	Remedy
The machine does not work (symbols are not illuminated).	Machine is not powered.	Check if: <ul style="list-style-type: none"> • power in the socket, • the fuse is OK, • plug is in the socket.
Washing program does not start (ON/OFF LED is flashing).	Door is not properly closed.	Push it towards the machine.
Water does not enter the machine (after approx. 8 min the machine reports failure - three flashes).	Disturbed water inlet.	Check if: <ul style="list-style-type: none"> • the water tap is open, • inlet pipe net filter is clean. Push the START button.
Water is leaking from the machine.	Filter is not tightly screwed in. Inlet pipe is not tightly screwed to the machine or to the water tap. Outlet pipe fell to the floor.	Tighten the filter properly. Tighten the inlet pipe. Affix the outlet pipe to the drain.
The machine moves during operation.	The machine is not properly leveled. Transport brackets are not removed.	Level the machine with the adjustable legs. Remove transport brackets.
The machine vibrates during the spin.	Unevenly distributed laundry, especially with very small quantities (for ex. only the bathrobe).	This is normal, the machine will reduce the RPM if vibrations are too strong. Wash larger quantity of laundry.
Excessive foaming during washing.	Excessive measure of detergent.	Use washing powder according to the instructions by the producer and according to the water hardness and soiled laundry. Use only detergents for machine washing.
Water is poorly pumped out or not at all (machine reports failure - seven flashes of LED).	Water outlet is clogged.	Check if: <ul style="list-style-type: none"> • the filter is clean, • outlet pipe is not jammed, • outlet pipe is positioned higher than 1m. Push START again.
Laundry is not properly spun. No failure is reported.	The machine switched on the UKS* function. Because of bad laundry balance, the machine has automatically reduced spin RPM.	The machine operates normally. Wash large and small pieces of laundry together.
Greasy wads appear on the laundry.	Too little detergent (laundry was very greasy).	Wash the laundry again. Add more detergent for such soiled laundry, or use liquid detergent.



Failure	Possible cause	Remedy
Laundry is stained after washing.	You used liquid detergent or detergent for colored laundry which does not contain whitener.	Use the detergent containing whitener.
White powdery residues on the laundry.	It is not the consequence of bad rinsing, but because of neo-phosphate detergents containing non soluble components (zeolites) for water softening. Such substances may be deposited upon the laundry.	Immediately rinse the laundry once again. <ul style="list-style-type: none"> • Use liquid detergents which do not contain zeolites. • Try removing the residues with the brush.
Detergent residues in the dispenser.	Low water flow pressure. Some detergents may stick to the dispenser rather hard if it is wet.	<ul style="list-style-type: none"> • Clean the inlet pipe filter net. • In case of low water pressure increase water level. • Wipe the dispenser prior loading detergent.
Softener is not completely rinsed, or water is left in the dispenser dish.	Sucking cover is not correctly positioned or is clogged.	Clean the dispenser and firmly fix the cover to its place.
Unpleasant smell in the washing machine drum.	Remains of fabrics, washing agent and softener in the filter.	Check whether the filter is clean.
Washing time is longer than usual.	<ul style="list-style-type: none"> • Low temperature of inlet water. • Due to unevenly distributed load, the machine has activated the UKS*. • Low mains voltage. • There has been a failure in the power supply. 	<ul style="list-style-type: none"> • Washing program time may be up to 60% longer; however, this does not imply a fault in the machine. • Washing time is extended by the power supply down-time.

* UKS: universal stability control - this function prevents excessive vibrations during spinning.

In case you were not successful in repairing the malfunctions in spite of the above suggestion chart, call the nearest authorized service shop. Repairing the failure arising from inappropriate connections or use of the appliance is not covered by the guarantee, and the repair expenses are paid by the customer.

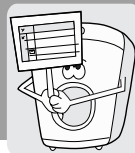

Program chart

Basic program	Max. load (kg)	Temp. (°C)	Spin (RPM)	Duration (min.)	Water cons. L			Energy cons. kWh		Additional function Pump stop 
					RPM			RPM		
					400 - 700	800 - 900	1000 - 1300	400 - 700	800 - 1300	
Cotton - white	6	95	1300	139	68	63	58	2,30/2,10**	2,10/2,05**	●
Cotton - color *	6	60		140/150	62	57	52	1,30/1,14**	1,14/1,02**	●
Cotton + prewash	6	60		165	70	65	60	1,50/1,34**	1,34/1,22**	●
Cotton	6	40		116	62	57	52	0,70/0,66**	0,66	●
Cotton - short	6	40		72	62	57	52	0,55	0,55	●
Synthetics	3	60	1000	111	43	43	43	0,93	0,93	●
Synthetics	3	40		100	40	40	40	0,52	0,52	●
Synthetics-short	3	40		49	40	40	40	0,47	0,47	●
Delicate	2,5	40	700	59	58	58	58	0,45	0,45	●
Delicate	2,5	30		53	58	58	58	0,36	0,36	●
Wool	2	30	600	46	42	42	42	0,20	0,20	●
Partial programs										
Rinse	3		700	25	40			0,02		
Softening	6		1000	15	16			0,02		
Pumping water	6		-	2						
Spin	6		1300	12				0,03		







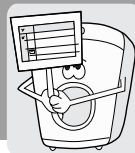

























● possible

* Testing program by EN 60456 with the selection of max. spin RPM.

** Depending on model.



Maintenance chart

Normal wash  Delicate wash 	 Max. washing temp. 95°C 	 Max. washing temp. 60°C 	 Max. washing temp. 40°C 	 Max. washing temp. 30°C 	 Manual washing	 Washing not allowed
 Whitening	 Whitening in cold water			 Whitening not allowed		
 Ironing	 Hot iron max. 200°C	 Hot iron max. 150°C	 Hot iron max. 110°C	 Ironing not allowed		
 Dry cleaning	 Dry cleaning in all solvents	 Perchlorin-ethylene R11, R113, Kerosene	 Dry cleaning in kerosene, in pure alcohol and in R 113	 Dry cleaning not allowed		
 Drying	 Place on flat surface	 Hang wet	 Hang	 High temperature  Low temperature	 Tumble drying not allowed	

